

Pairing Buttons To Your In-Home System



PAIRING YOUR HELP BUTTONS

Which System Do You Have?

Every In-Home System comes with a Personal Help Button automatically paired to the Base Unit. However, additional buttons such as extra Personal Help Buttons or Wall Buttons (at an additional cost) need to be paired to the system by the customer if they were bought after the initial purchase.

To ensure that your new button will call for help, please follow the directions for pairing your button(s) to the right model of your Base Unit. The Landline and 4G Cellular Base Unit can be differentiated by comparing the buttons on the rear of the Base Unit as seen below.

1) Landline Base Unit 2

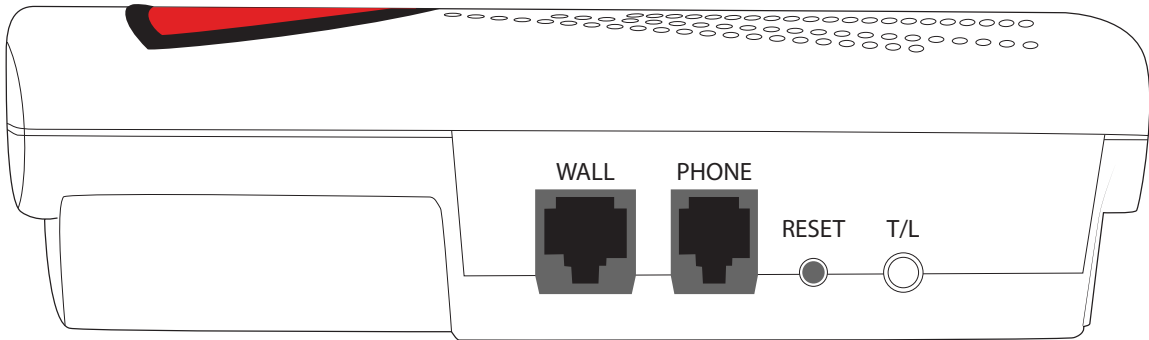

2) 4G Cellular Base Unit 5

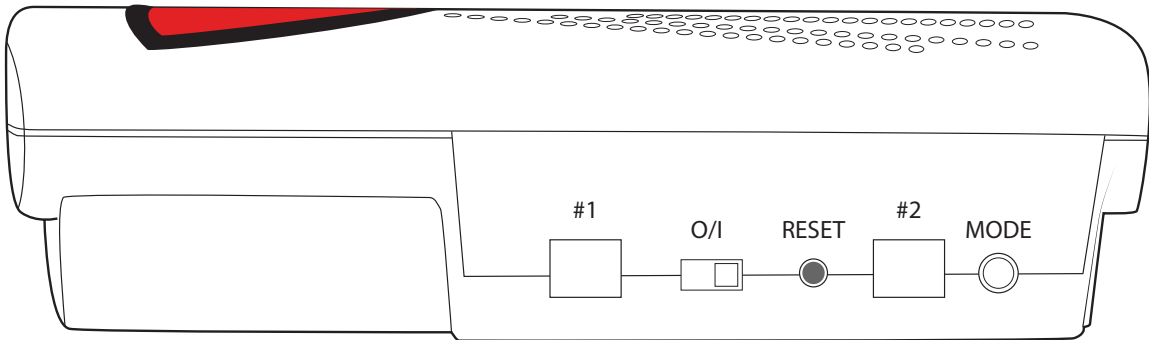

IN-HOME SYSTEM - LANDLINE

Pairing Personal Help Buttons

Your Personal Help Button must be paired to your Base Unit and tested before it will work. Please follow the instructions below. For Wall Buttons, please see next page:

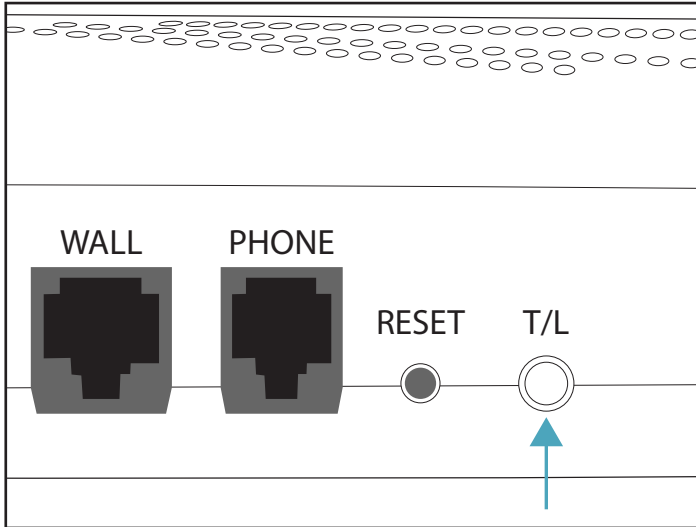

1) Press the white T/L button on the rear of the Base Unit.

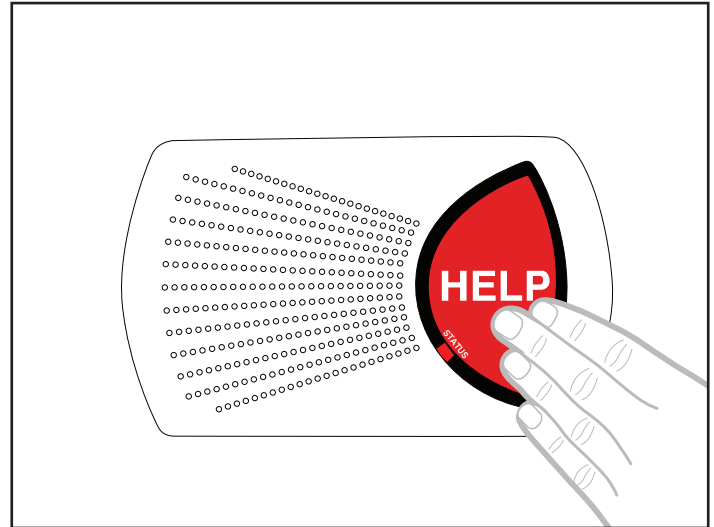

2) Then press the large, red HELP button on top of the Base Unit once.

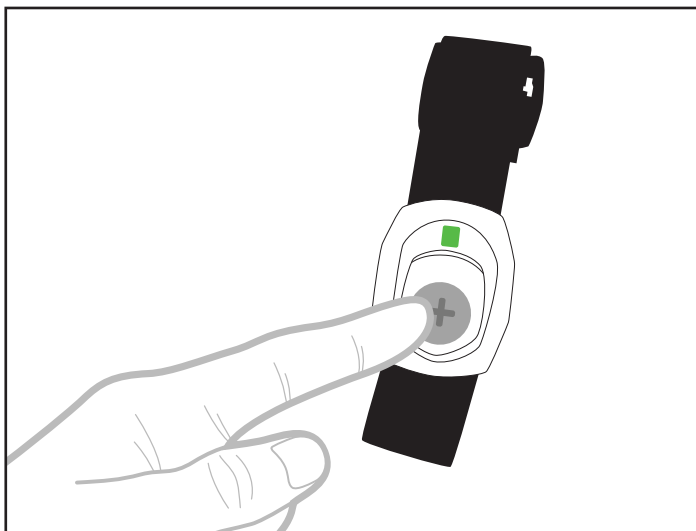

3) Press your Personal Help Button once.

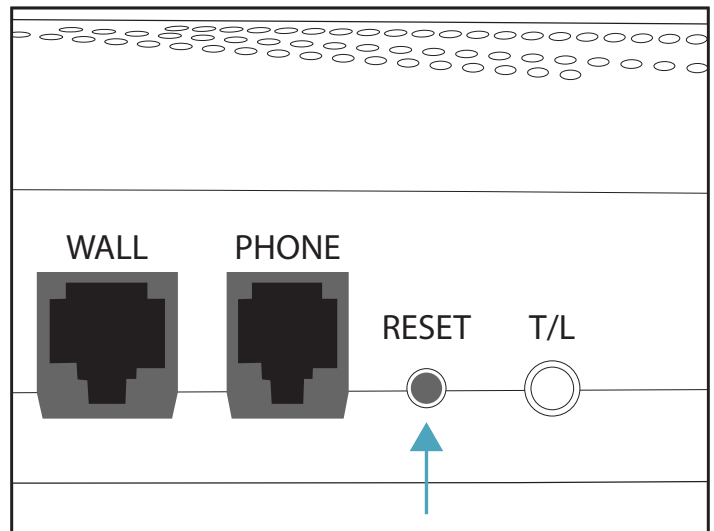

4) On the rear of the Base Unit, press the black RESET button once. Now test your Personal Help Button once. Please wait for the unit to connect to the monitoring center. Advise the dispatcher that you are testing.

5) If you have any Wall Buttons, please pair them to the Base Unit using the directions on the next page. If you have paired all your buttons, please perform a Range Test (page 4) to identify areas where the button may not work.

IN-HOME SYSTEM - LANDLINE

Pairing Wall Buttons

Your Wall Button must be paired to your Base Unit and tested before it will work. Please follow the instructions below:

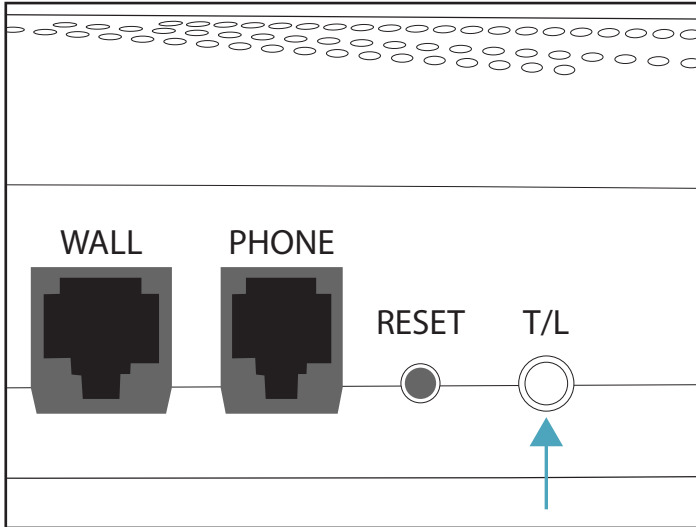

1) Press the white T/L button on the rear of the Base Unit.

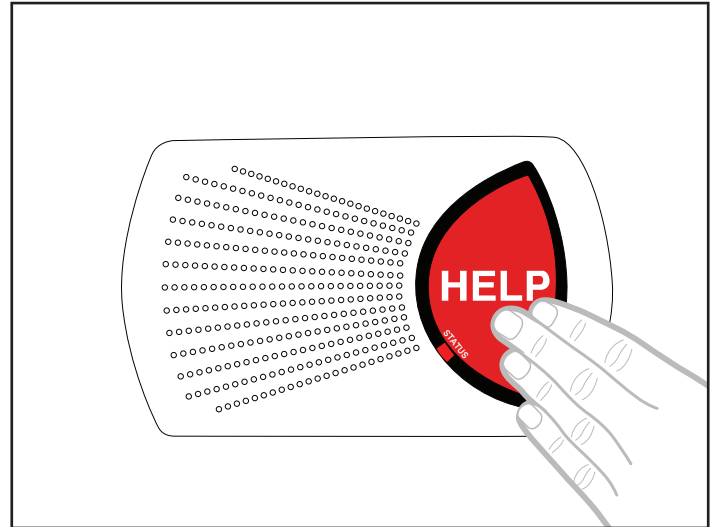

2) Then press the large, red HELP button on the Base Unit twice. Make sure you hear it say “Group 2.” If you don’t hear it, press the RESET button and start from Step 1.

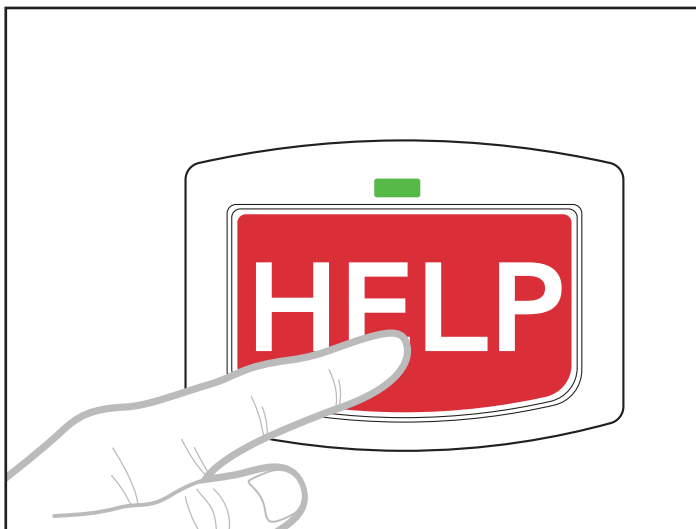

3) Press your Wall Button once. You should hear 1 beep if the unit and buttons is paired.

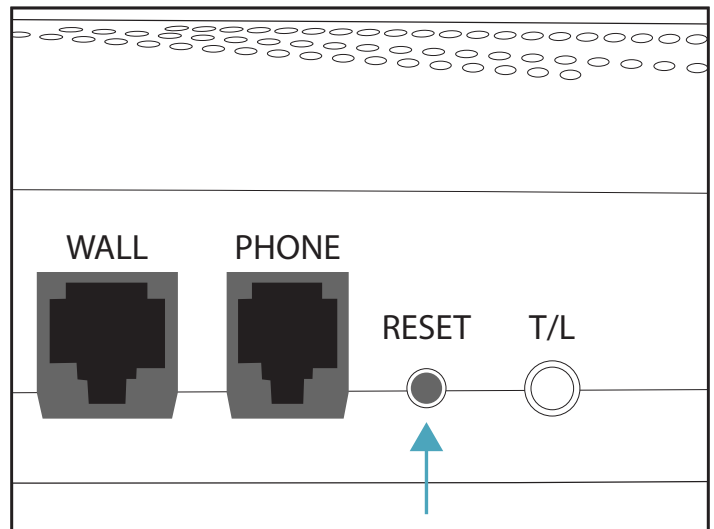

4) On the rear of the Base Unit, press the black RESET button once. Now test your Wall Button by pressing it once. Please wait for the unit to connect to the monitoring center. Advise the dispatcher that you are testing.

5) After pairing all your buttons with the Base Unit, please perform a Range Test on the next page to identify areas where the button may not work.

IN-HOME SYSTEM - LANDLINE

Range Test: Testing The Range of Your Buttons

Test the range of the buttons to ensure they work throughout your home and yard. It may be helpful to have a second person assist with this range test, with one person staying by the Base Unit and the other person press down the button.

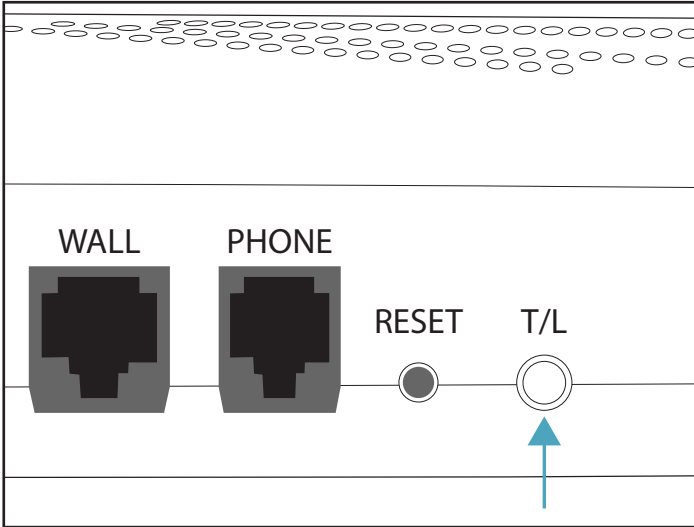

1) On the rear of the Base Unit, press the T/L button one time. The unit will announce, "Range Test Mode."

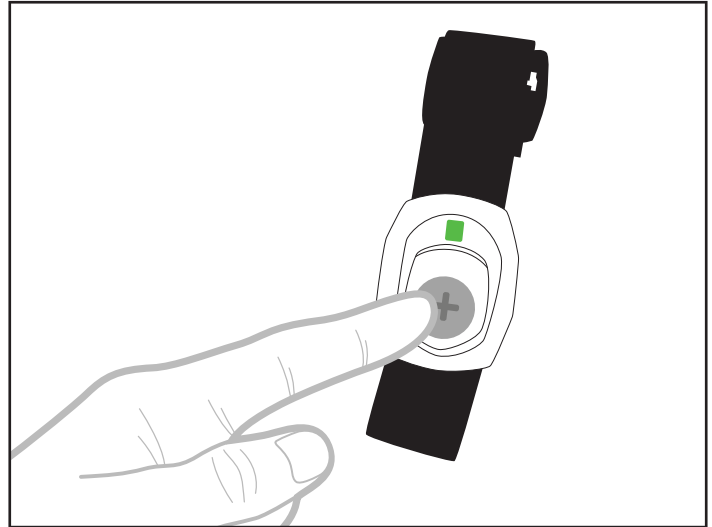

2) Immediately press and hold down the button. A steady tone will sound from the Base Unit. This means the unit is detecting the button.



3) For Personal Help Buttons, walk around all areas of the home and yard while holding it down. Listen for the steady tone from the Base Unit. For Wall Buttons, hold the button down in the area where you want to place the button. Take note of any areas where the tone stops. The stops indicate that the button cannot call for help in that area.

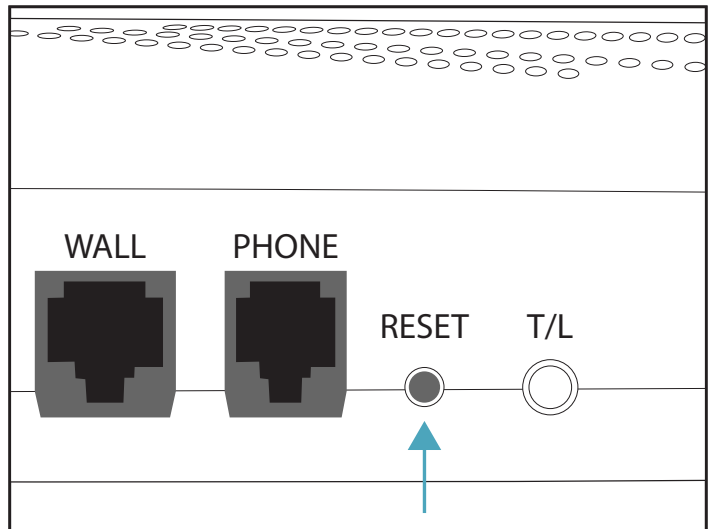

4) Once all areas are tested, stop pressing down the button. Then press the black "RESET" button on the rear of the Base Unit. It will announce, "System Ready." If stops were detected, try relocating the Base Unit and perform the test again, and/or contact your service provider.

NOTE: Metal objects, mirrors, aluminum siding, and electronic devices (i.e. clock radios, televisions, microwaves) MIGHT prevent the signal from reaching your Base Unit. It may be helpful to relocate your Base Unit, or move the object that is preventing the signal.

IN-HOME SYSTEM - CELLULAR

Pairing Personal Help Buttons

Your Personal Help Button must be paired to your Base Unit and tested before it will work. Please follow the instructions below. For Wall Buttons, please see next page:

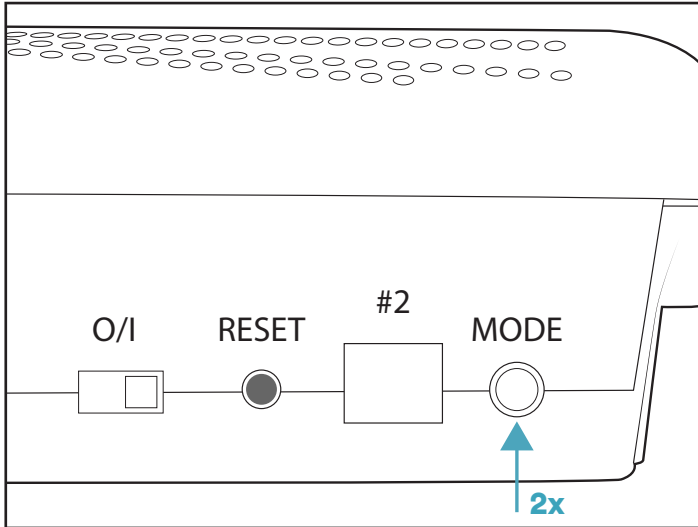

1) Press the white MODE button on the rear of the Base Unit twice (2x).

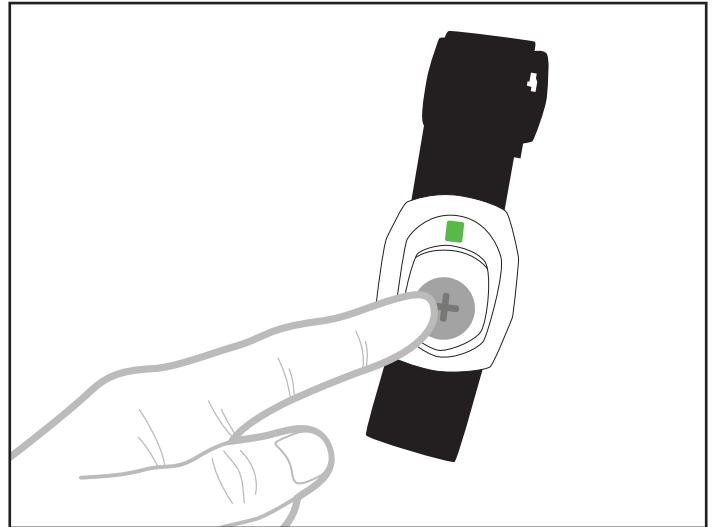

2) Press your Personal Help Button once. You should hear a beep which means the unit and the button is paired.

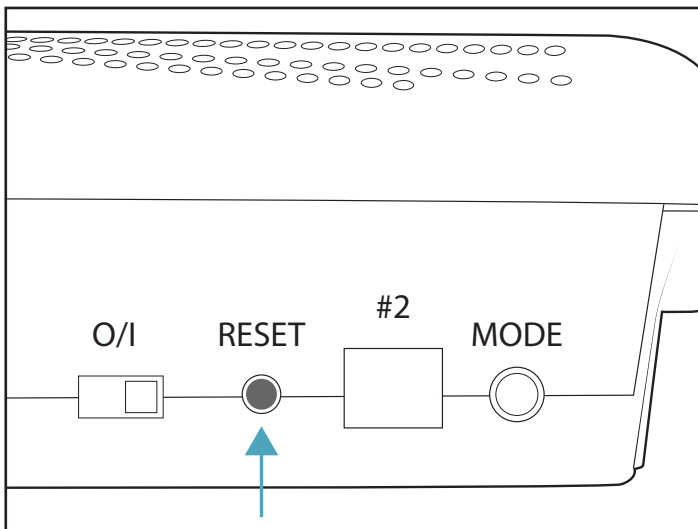

3) Press the Black RESET button on the rear of the Base Unit once.

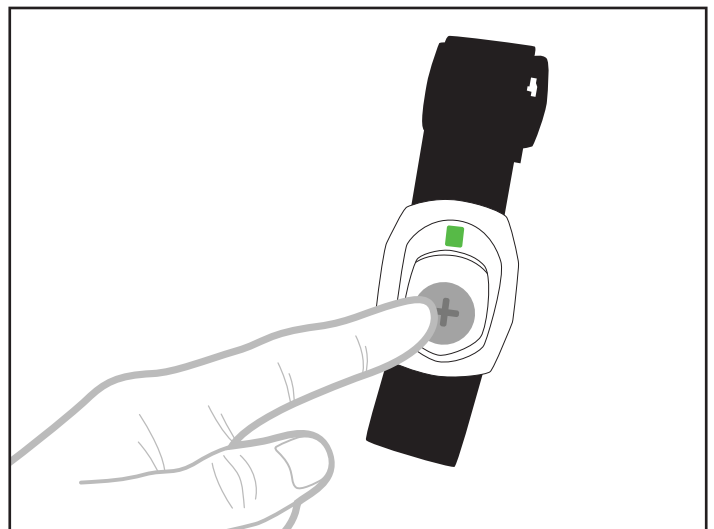

4) Now test your Personal Help Button by pressing it once. Please wait for the unit to connect to the monitoring center. Advise the dispatcher that you are testing.

5) If you have any Wall Buttons, please pair them to the Base Unit using the directions on the next page. If you have paired all your buttons, please perform a Range Test (page 7) to identify areas where the button may not work.

IN-HOME SYSTEM - CELLULAR

Pairing Wall Buttons

Your Wall Button must be paired to your Base Unit and tested before it will work. Please follow the instructions below:

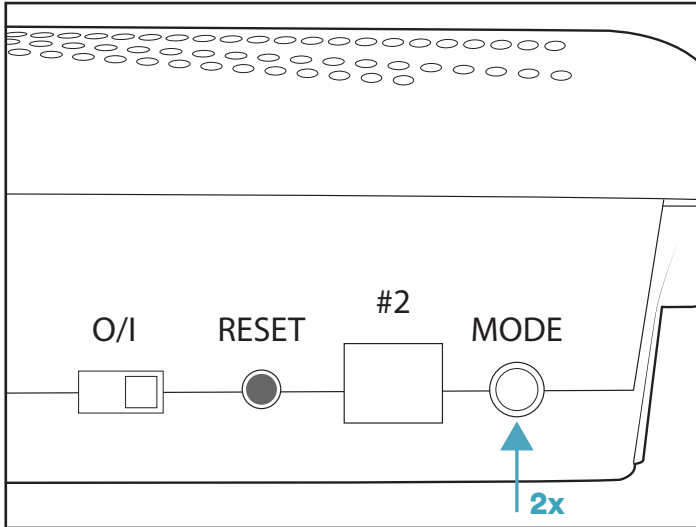

1) Press the white MODE button on the rear of the Base Unit twice (2x).

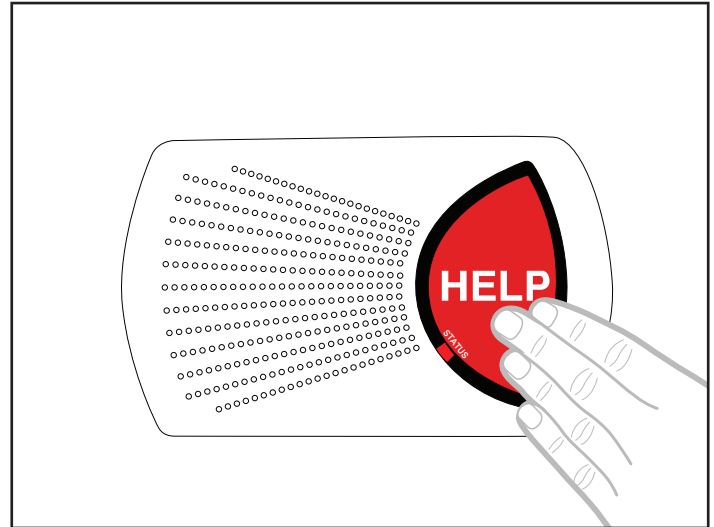

2) Press the large, red HELP button on top of the Base Unit twice (2x). Make sure you hear it say "Zone 2." If you don't hear "Zone 2", press the RESET button and start from Step 1.

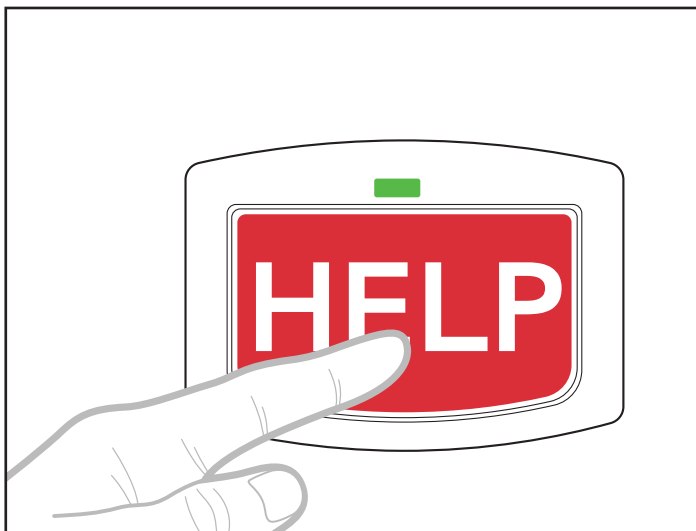

3) Press your Wall Button once. You should hear 1 beep if the unit and buttons is paired.

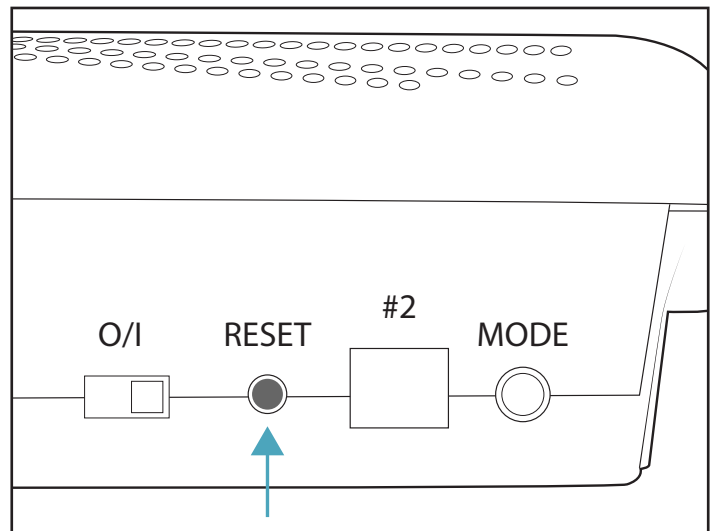

4) On the rear of the Base Unit, press the black RESET button once. Now test your Wall Button by pressing the Wall Button once. Please wait for the unit to connect to the monitoring center. Advise the dispatcher that you are testing.

5) After pairing all your buttons with the Base Unit, please perform a Range Test on the next page to identify areas where the button may not work.

IN-HOME SYSTEM - CELLULAR

Range Test: Testing The Range of Your Buttons

Test the range of the buttons to ensure they work throughout your home and yard. It may be helpful to have a second person assist with this range test, with one person staying by the Base Unit and the other person pressing down the button.

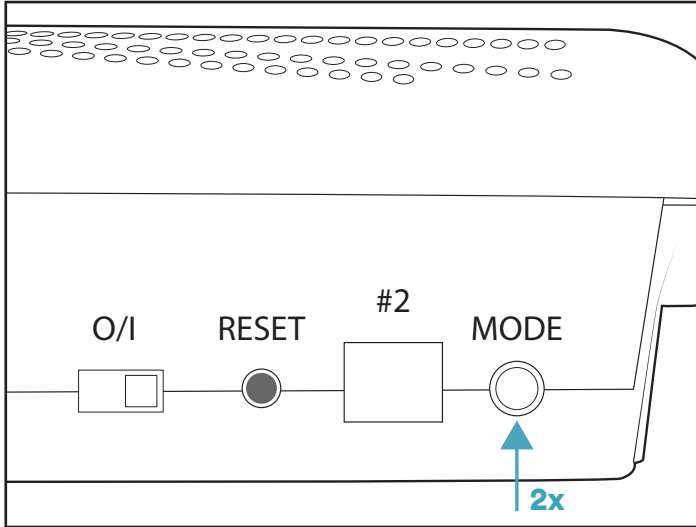

1) On the rear of the Base Unit, press the MODE button twice (2x). The unit will announce, "Range Test Mode."

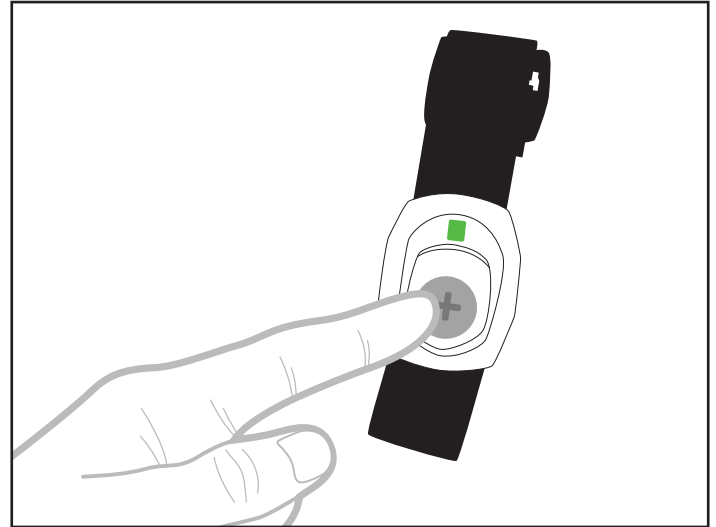

2) Immediately press and hold down the button. A steady tone will sound from the Base Unit. This means the unit is detecting the button.



3) For Personal Help Buttons, walk around all areas of the home and yard while holding it down. Listen for the steady tone from the Base Unit. For Wall Buttons, hold the button down in the area where you want to place the button. Take note of any areas where the tone stops. The stops indicate that the button cannot call for help in that area.

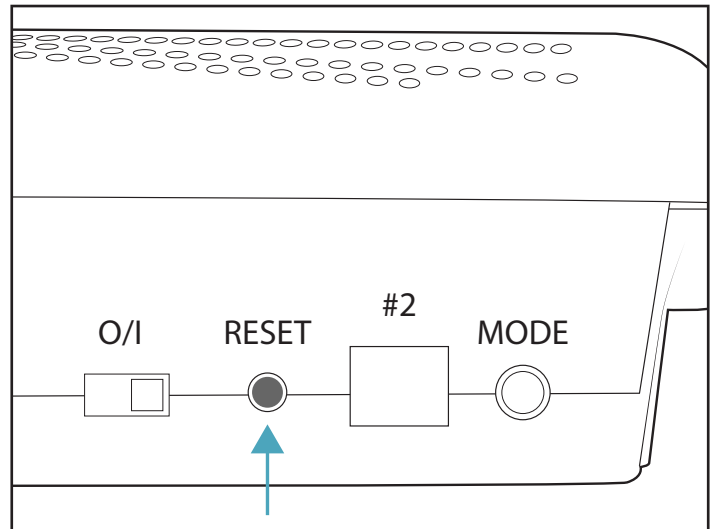

4) Once all areas are tested, stop pressing down the button. Then press the black "RESET" button on the rear of the Base Unit. It will announce, "System Ready." If stops were detected, try relocating the Base Unit and perform the test again, and/or contact your service provider.